



CONTACTOR, AC-3 15 KW/400 V, AC 110 V, 50 HZ, 3-POLE, SIZE S2, SCREW CONNECTION

Figure similar

product brand name	SIRIUS
Product designation	power contactor

General technical data:

Size of contactor	S2
Insulation voltage	
• Rated value	690 V
Degree of pollution	3
Surge voltage resistance Rated value	6 kV
Mechanical service life (switching cycles)	
• of the contactor typical	10 000 000
• of the contactor with added electronics-compatible auxiliary switch block typical	5 000 000
• of the contactor with added auxiliary switch block typical	10 000 000
Protection class IP	
• on the front	IP00
• of the terminal	IP00
Equipment marking	
• acc. to DIN EN 61346-2	Q
• acc. to DIN EN 81346-2	Q

Ambient conditions:

Installation altitude at height above sea level maximum	2 000 m
Ambient temperature	
• during operation	-25 ... +60 °C

- during storage

-55 ... +80 °C

Main circuit:

Number of poles for main current circuit	3
Number of NC contacts for main contacts	0
Number of NO contacts for main contacts	3
Connectable conductor cross-section in main circuit at AC-1	
<ul style="list-style-type: none"> • at 60 °C minimum permissible 	10 mm ²
<ul style="list-style-type: none"> • at 40 °C minimum permissible 	16 mm ²
Operating current	
<ul style="list-style-type: none"> • at AC-1 at 400 V <ul style="list-style-type: none"> — at ambient temperature 40 °C Rated value 	50 A
<ul style="list-style-type: none"> • at AC-1 up to 690 V <ul style="list-style-type: none"> — at ambient temperature 40 °C Rated value — at ambient temperature 60 °C Rated value 	50 A 45 A
<ul style="list-style-type: none"> • at AC-3 <ul style="list-style-type: none"> — at 400 V Rated value — at 690 V Rated value 	32 A 20 A
<ul style="list-style-type: none"> • at AC-4 at 400 V Rated value 	29 A
Operating current for ≥ 200000 operating cycles at AC-4	
<ul style="list-style-type: none"> • at 400 V Rated value 	15.6 A
<ul style="list-style-type: none"> • at 690 V Rated value 	11 A
Operating current	
<ul style="list-style-type: none"> • with 1 current path at DC-1 <ul style="list-style-type: none"> — at 24 V Rated value — at 110 V Rated value 	45 A 4.5 A
<ul style="list-style-type: none"> • with 2 current paths in series at DC-1 <ul style="list-style-type: none"> — at 24 V Rated value — at 110 V Rated value 	45 A 25 A
<ul style="list-style-type: none"> • with 3 current paths in series at DC-1 <ul style="list-style-type: none"> — at 24 V Rated value — at 110 V Rated value 	45 A 45 A
Operating current	
<ul style="list-style-type: none"> • with 1 current path at DC-3 at DC-5 <ul style="list-style-type: none"> — at 24 V Rated value — at 110 V Rated value 	35 A 2.5 A
<ul style="list-style-type: none"> • with 2 current paths in series at DC-3 at DC-5 <ul style="list-style-type: none"> — at 110 V Rated value — at 24 V Rated value 	25 A 45 A
<ul style="list-style-type: none"> • with 3 current paths in series at DC-3 at DC-5 	

— at 110 V Rated value	45 A
— at 24 V Rated value	45 A
Operating power	
• at AC-1	
— at 230 V at 60 °C Rated value	18 kW
— at 690 V at 60 °C Rated value	54 kW
Operating power for ≥ 200000 operating cycles at AC-4	
• at 400 V Rated value	8.2 kW
• at 690 V Rated value	10 kW
Thermal short-time current restricted to 10 s	320 A
Active power loss at AC-3 at 400 V for rated value of the operating current per conductor	1.8 W
No-load switching frequency	
• with AC	5 000 1/h
Operating frequency	
• at AC-1 maximum	1 200 1/h
• at AC-2 maximum	750 1/h
• at AC-3 maximum	1 000 1/h
• at AC-4 maximum	250 1/h

Control circuit/ Control:

Type of voltage of the control supply voltage	AC
Control supply voltage with AC	
• at 50 Hz Rated value	110 V
• Rated value	50 Hz
Operating range factor control supply voltage rated value of the magnet coil with AC	
• at 50 Hz	0.8 ... 1.1
Apparent pick-up power of the magnet coil with AC	104 V·A
Inductive power factor with closing power of the coil	0.78
Apparent holding power of the magnet coil with AC	9.7 V·A
Inductive power factor with the holding power of the coil	0.42
Closing delay	
• with AC	11 ... 30 ms
Arcing time	10 ... 15 ms

Auxiliary circuit:

Number of NC contacts	
• for auxiliary contacts	
— instantaneous contact	0
Number of NO contacts	
• for auxiliary contacts	

— instantaneous contact	0
Operating current at AC-12 maximum	10 A
Operating current at AC-15	
• at 230 V Rated value	6 A
• at 400 V Rated value	3 A
Operating current at DC-12	
• at 60 V Rated value	6 A
• at 110 V Rated value	3 A
• at 220 V Rated value	1 A
Operating current at DC-13	
• at 24 V Rated value	10 A
• at 60 V Rated value	2 A
• at 110 V Rated value	1 A
• at 220 V Rated value	0.3 A
Contact reliability of the auxiliary contacts	1 faulty switching per 100 million (17 V, 1 mA)

UL/CSA ratings:

Contact rating of the auxiliary contacts acc. to UL	A600 / Q600
--	-------------

Short-circuit:

Design of the fuse link	
• for short-circuit protection of the main circuit	
— with type of assignment 1 required	fuse gL/gG: 125 A
— with type of assignment 2 required	fuse gL/gG: 63 A
• for short-circuit protection of the auxiliary switch required	fuse gL/gG: 10 A

Installation/ mounting/ dimensions:

Mounting type	screw and snap-on mounting onto 35 mm standard mounting rail according to DIN EN 50022
• Side-by-side mounting	Yes
Height	112 mm
Width	55 mm
Depth	115 mm
Required spacing	
• for grounded parts	
— at the side	6 mm

Connections/ Terminals:





Type of electrical connection	
• for main current circuit	screw-type terminals
• for auxiliary and control current circuit	screw-type terminals
Type of connectable conductor cross-section	
• for main contacts	
— solid	2x (0.75 ... 16 mm ²)





- stranded 2x (0.75 ... 25 mm²)
- single or multi-stranded 2x (0,75 ... 16 mm²)
- finely stranded with core end processing 2x (0.75 ... 16 mm²)
- finely stranded without core end processing 2x (0.75 ... 16 mm²)
- for AWG conductors for main contacts 2x (18 ... 2)

Type of connectable conductor cross-section

- for auxiliary contacts
 - solid 2x (0.5 ... 1.5 mm²), 2x (0.75 ... 2.5 mm²), max. 2x (0.75 ... 4 mm²)
 - finely stranded with core end processing 2x (0.5 ... 1.5 mm²), 2x (0.75 ... 2.5 mm²)
- for AWG conductors for auxiliary contacts 2x (20 ... 16), 2x (18 ... 14), 1x 12

Certificates/ approvals:

General Product Approval	Functional Safety/Safety of Machinery	Declaration of Conformity	Test Certificates
  	Type Examination		Type Test Certificates/Test Report

Test Certificates	Shipping Approval
Special Test Certificate	    

Shipping Approval	other
	other Environmental Confirmations Confirmation

Further information

Information- and Downloadcenter (Catalogs, Brochures,...)

<http://www.siemens.com/industrial-controls/catalogs>

Industry Mall (Online ordering system)

<http://www.siemens.com/industrymall>

Cax online generator

<http://support.automation.siemens.com/WW/CAXorder/default.aspx?lang=en&mlfb=3RT10341AF00>

Service&Support (Manuals, Certificates, Characteristics, FAQs,...)

<https://support.industry.siemens.com/cs/ww/en/ps/3RT10341AF00>

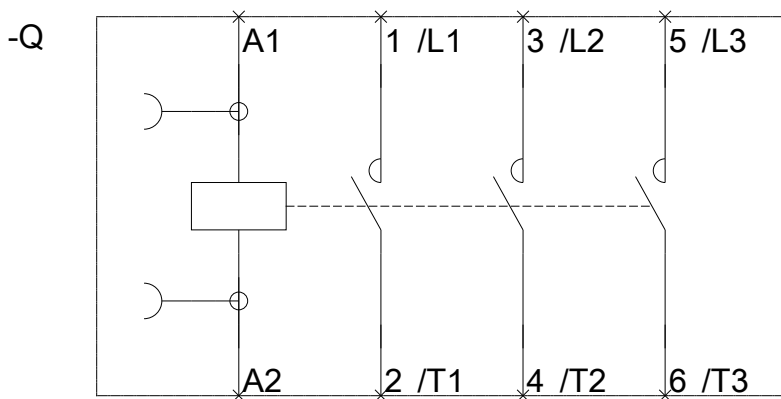
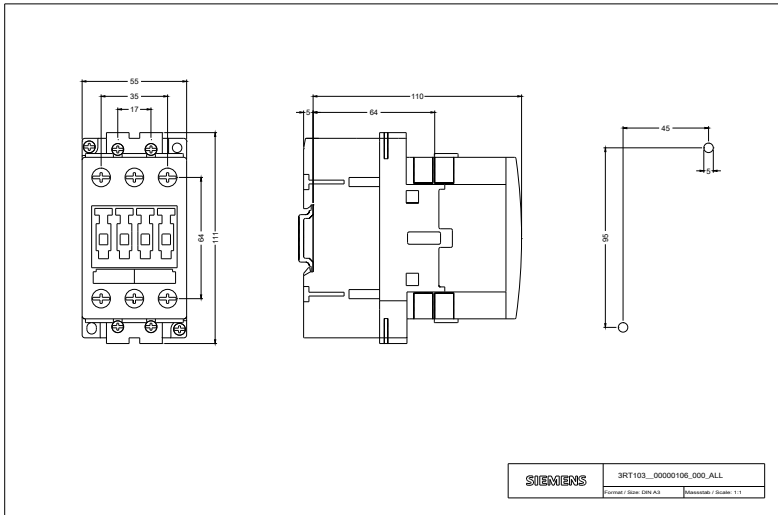

last modified:

02.06.2015